

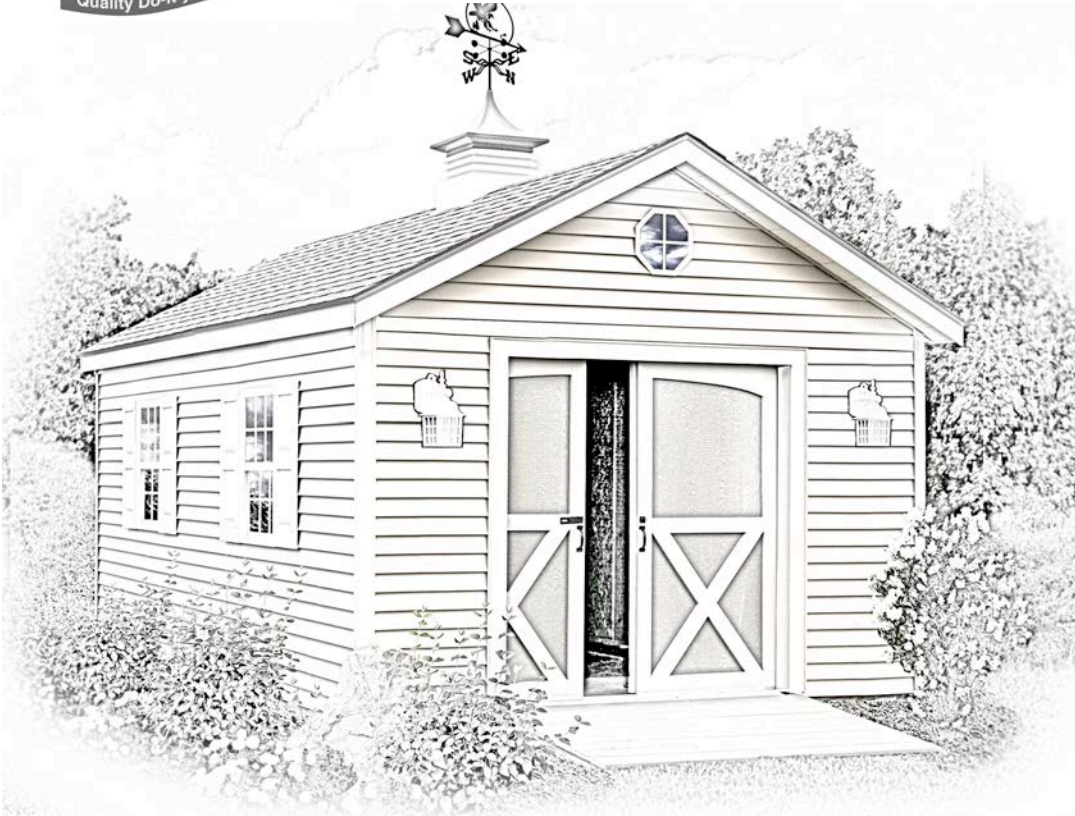

Best Barns USA

Assembly Book

Revised September 13, 2017



***the South Dakota
with pocket doors***

12' x 20'

Manufactured by Reynolds Building Systems, Inc.

205 Arlington Drive - Greenville, PA 16125

This manual is copyrighted. Under the copyright laws, this manual may not be copied, in whole or in part, without consent from Reynolds Building Systems, Inc. © Copyright 2011

IMPORTANT INFORMATION ABOUT YOUR SHED KIT

Download the most current instruction book at www.barnkits.com; use the "manuals" link on the menu bar and then select your building kit and size.

Thank you for purchasing our kit. The material that is included in our kit is listed on the back page. The optional floor package, siding, roof sheathing and longer 1x6 fascia trim will be supplied by a local lumber supplier.

Our kit does not include the shingles; the quantity needed is listed on the back page.

Our framing lumber is imported to provide you the highest quality available. However, if you need to replace any lumber for any reason please do so and we will reimburse you.

IMPORTANT: Unpack the material from the pallet, then unscrew the bottom 2x4s from the pallet runners. The bit for the screws is packed in the hardware bag.

Stacking the boards, according to size, will make them easier to find when needed. Some boards may have colored ends. **Do Not** discard any material until your building is complete.

If you have any questions about assembling the kit, call 800-245-1577. If you are calling after normal business hours, call 724-866-HELP (4357) or email to help@barnkits.com.

Before you begin construction, be sure to study this assembly manual. Also, obtain a building permit and check all pertinent building code regulations.

Thank you for your purchase.

Bill & Linda Rinella, owners

Vinyl Siding Overview

Starter Strip is installed along the bottom of the building.

Center the nail in the nailing slots. **DO NOT** nail the siding tight. The panels should float on the nails to provide for expansion and contraction. Nail into wall studs wherever possible. If it is necessary to nail between the studs, cutoff the tips of nails that protrude through the siding.

When installed, the siding panels should have 1/4" free space at each end of the siding panel. This will allow the panel to expand with changes in temperature.

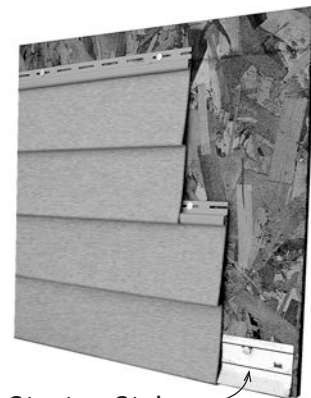

Starter Strip

Tool List

- | | |
|--|---|
| <input type="checkbox"/> Hammer & Phillips Screwdriver | <input type="checkbox"/> Power Drill/Screwdriver |
| <input type="checkbox"/> Framing Square & Level | <input type="checkbox"/> Measuring Tape |
| <input type="checkbox"/> Hand or Circular Saw | <input type="checkbox"/> 2-8' Step Ladders |

Always wear safety glasses when cutting or nailing!

Constructing Details for Deluxe Floor System

Deluxe floors include 4x4 runners, standard floors do not.

Foundation size is 12'-0" x 20'-0". Check local building codes in your area, the construction may have to change. For a concrete slab, install sill sealer as a moisture barrier between the concrete and the wall plates. Foam sill sealer can be purchased at home centers in rolls 3-1/2" or wider.

1. Stagger the 4x4 timbers as shown below. Cut (2) two 2x4- 8' boards into 2' long blocks to secure the 4x4s where they butt together.

2. Cut (2) two 2x4-8' to a length of 8' -0". They will be used for the joist headers. Layout, from left, for 16" on center joist spacing. 'X' marks where floor joist will be placed.

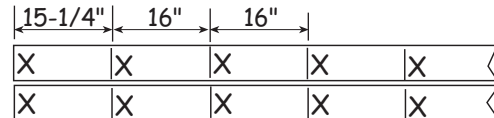

3. Cut (17) seventeen 2x4-12' treated boards to 11' -9". These will be the floor joists. *Treated lumber may be thicker than 1-1/2". Take this into account when cutting the length of floor joists. Shorten joist measurements if necessary to obtain 12'-0" building width.*
4. Install the floor joists cut above between the 8' joist headers. Secure with 16d galv. deck nails.
5. Place floor assembly over the 4x4s. Square floor assembly. Measure the floor diagonally (corner to corner) and then the opposite corners; these measurements will be the same when the floor is square. Toenail frame (headers & joists) to the 4x4 runners.

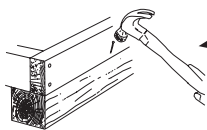
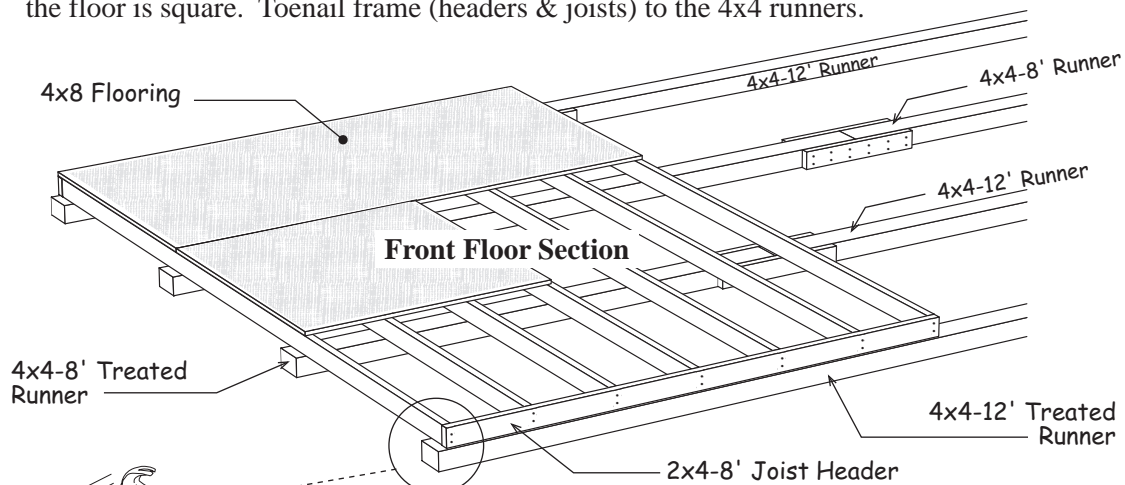

Assembly Instructions for Rear Floor Section

6. Cut (2) two 2x4-12' to a length of 12' -0". Layout for 16" joist spacing, *See above.*
7. Install floor joists between the joist headers. Square the floor section and install against the section assembled above. Toenail to the 4x4s runners.
8. Install 4x8 flooring over the 2x4s. Use 8d galv. spiral nails spaced 8" apart.

Material Description	12' x 20'
2x4 Treated Blocking	2 pcs. 8'
2x4 PT Joist Headers	2 pcs. 8'
2x4 PT Joist Headers	2 pcs. 12'
2x4 PT Floor Joist	17 pcs. 12'
4x4 Treated Runners	4 pcs. 8'
4x4 Treated Runners	4 pcs. 12'
Flooring 5/8" or 3/4"	8 pcs. 4x8
Galv Spiral Floor Nails	3 lb. 8d
Galvanized Deck Nails	5 lb. 16d

Step 1 Assemble Trusses

 **Building Tip:** To aid in the assembly of the trusses, temporarily screw 2x4 blocks to the floor. There are short 2x4s, *that may have an angle on one end*, supplied in kit.

1. Screw (2) two 2x4 blocks to the 12' wide end of the floor at the top corner, *see below*.
2. Place two truss legs together. Position the notch in the 2x4s (called a bird's mouth) into the 2x4 blocks. **Important:** You must have 12'-0" between the bird's mouth. Affix more 2x4 blocks above the truss legs to hold the truss members in place.
3. Secure the tops together with a wood gusset. Apply wood glue between the 2x4 boards and the gusset. Nail the gusset to the 2x4s with 6d common nails. Use 14 nails per gusset.
4. Install a 2x4-90° collar tie between the 2x4 boards. Hold in place with 2x4 blocks. Install 12"x24" gussets to the ends of the collar tie. Glue and nail using 14 nails per gusset.
5. Turn this truss over and apply wood gussets to the opposite side.
6. Repeat 2 through 5 to assemble (8) eight more trusses.

Do Not remove blocks from floor until completing **Step 2**.

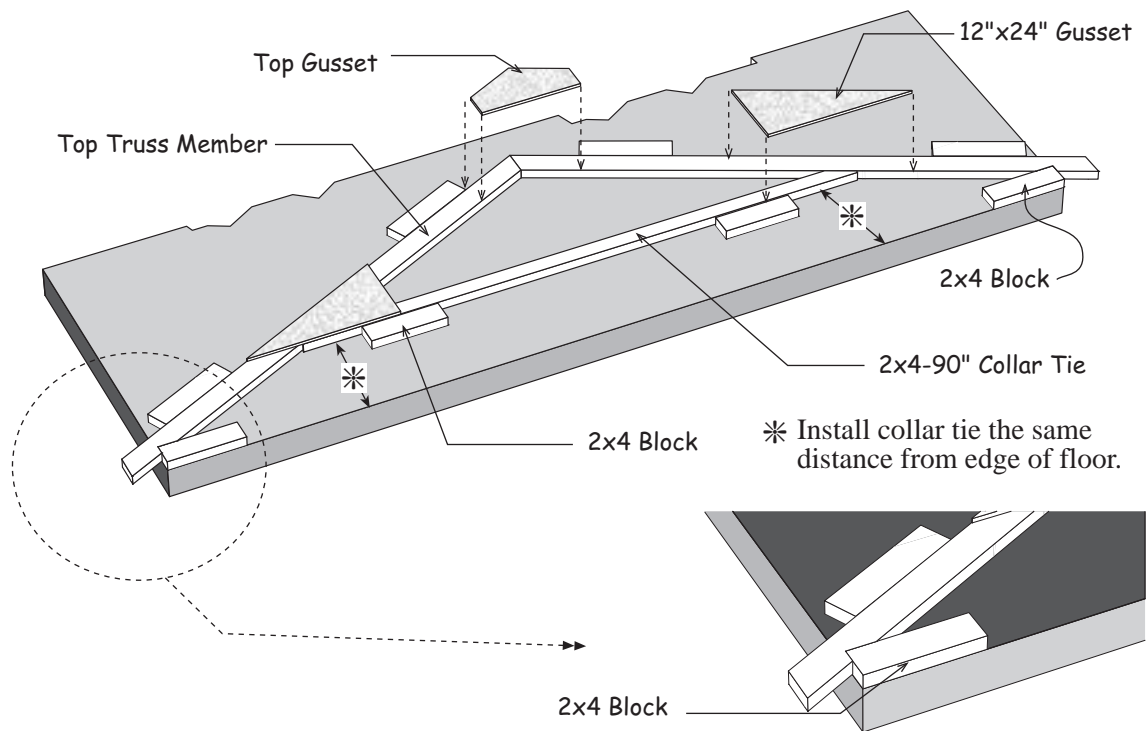

Step 2 Assemble Roof Gables

1. Butt (2) two 72" long 2x4s together and secure by nailing a 3-1/2" x 31-3/4" long plywood gusset across the top where they butt together. Use glue and 6d common nails.

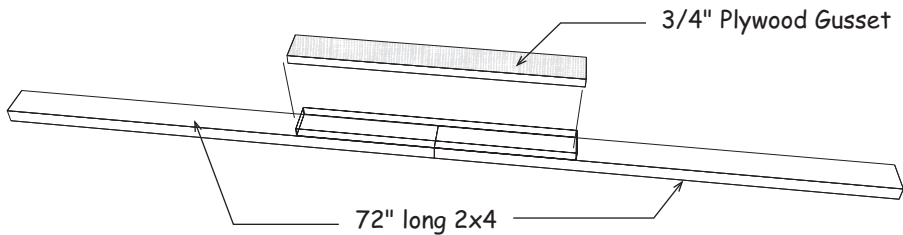

2. Place (2) two truss members in the jig. Secure the top together with a barbed metal plate.
3. Remove the 2x4 blocks at the corners of the floor and insert the gable plate assembled above into the bird's mouth. Make sure the 2x4 gable plate is straight. If necessary, tack 2x4 blocks to hold plate straight.

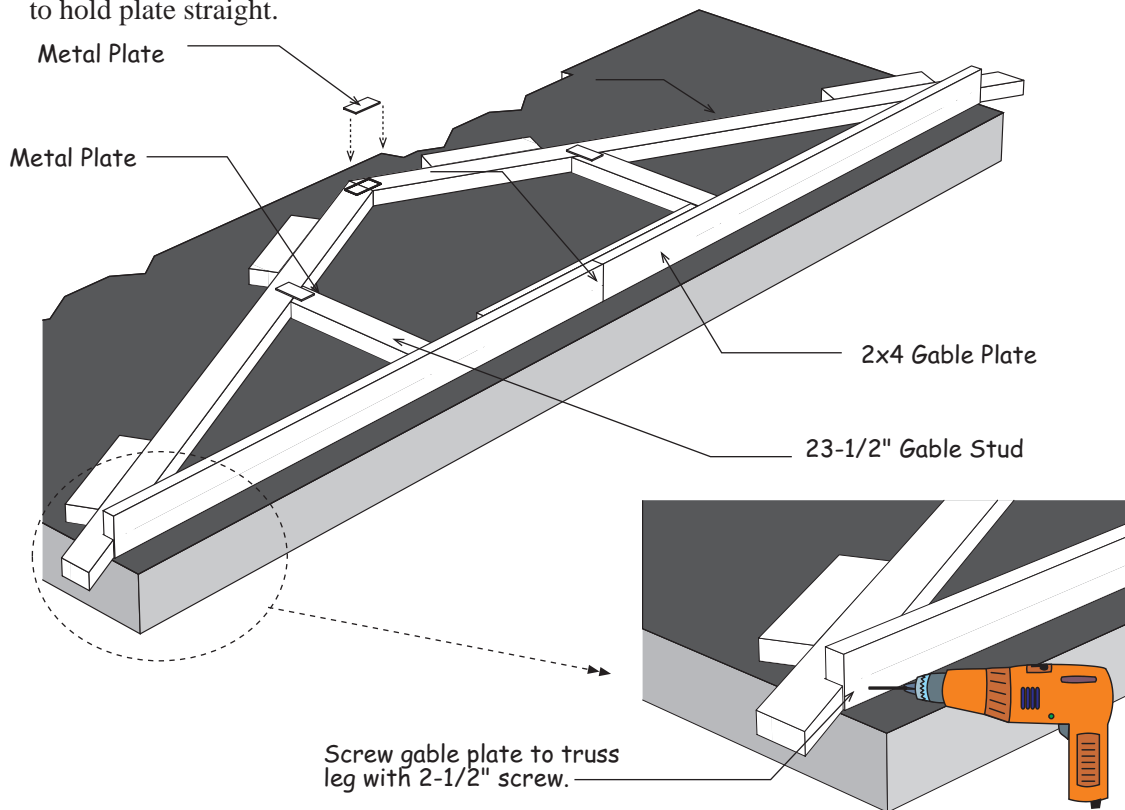

4. Remove the two 2x4 blocks that held the collar tie in position.
5. Install 2x4x23-1/2" gable studs. Nail through the bottom plate with 10d sinkers and secure the top with metal drive-on plates.
6. Repeat steps 1-5 to assemble another gable. Remove 2x4 blocks.

Step 3 Install Siding on Gables

1. Select one of the gable frames, Turn the gable over letting the bottom plate overhang the floor so the gable lays flat.
2. Cut a siding panel 40" in length. This will be used for the center of the gable. Cut the remaining siding panel in half for the ends of the gable.
3. Temporarily position all three siding panels on gable frame starting at left working right. Insure bottom of panels are flush with bottom plate. Mark siding flush with top of gable frame and cut along mark. Install siding using 7d sinkers.
4. Install pre-cut siding (*included in the kit*) on the ends of the gable. These pieces should extend 1/2" below bottom of 2x4 to receive soffit when installed later.
5. Install siding on the other gable frame.

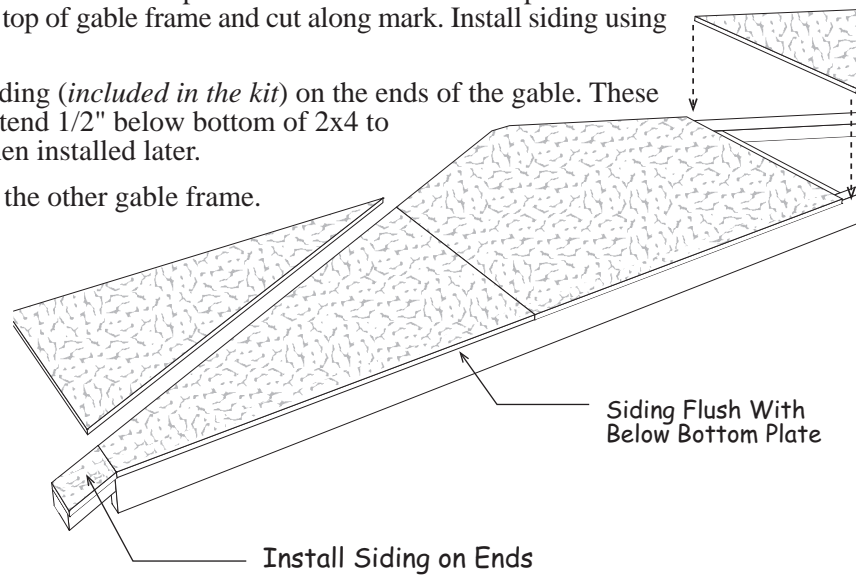

Step 4 Assemble Front Door Walls

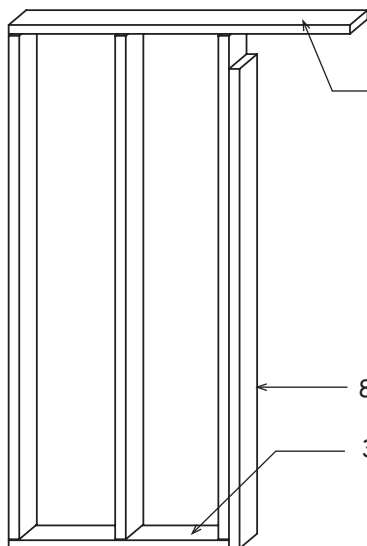

1. Install (3) three 2x4-7' wall studs between a 31" long bottom plate and a 47-1/2" long top plate. Install the middle stud in the center of the bottom plate.
2. Cut a 2x4-7' board to 80" and install on the end of the wall frame to support the door header.
3. Repeat to assemble another wall frame.

Step 5 Assemble 12' Back Wall

1. Position 2x4-68-1/2" boards together and indicate with 'X' marks, where the wall studs will be located. Mark the ends that will butt together with the letters 'A' and 'B'.

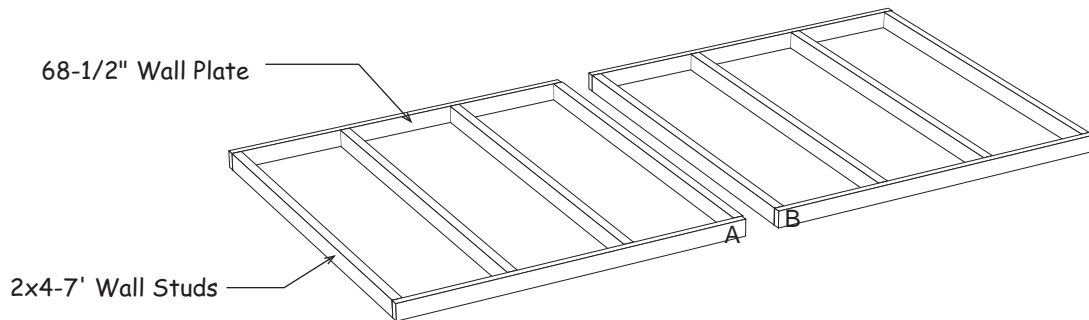
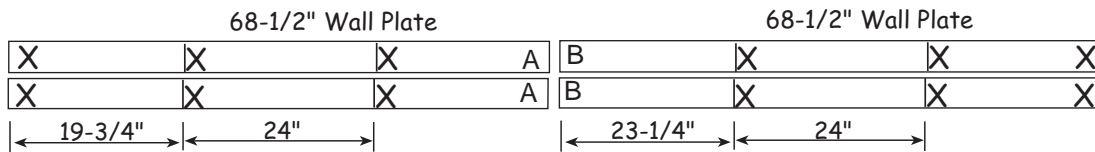

2. Install 2x4-7' wall studs between the top and bottom plates. Assemble wall frames with 10d sinkers, two (2) nails at each stud end. Nail both wall frames together.
3. Square wall frame. *Measure diagonally (corner to corner). The measurements will be the same when the wall is square.*
4. Cut (3) three siding panels to a length of 87-3/4". Install the 1st siding panel with the 'LAP' edge extending 3-1/2" past the wall frame. The bottom will extend 3/4" below the bottom plate. Tip: Use 3/4" trim board as a gauge. Use 8d galv. nails, 12" apart.
5. Install the other siding panels. Cut the last panel to extend 3-1/2" beyond the wall frame.

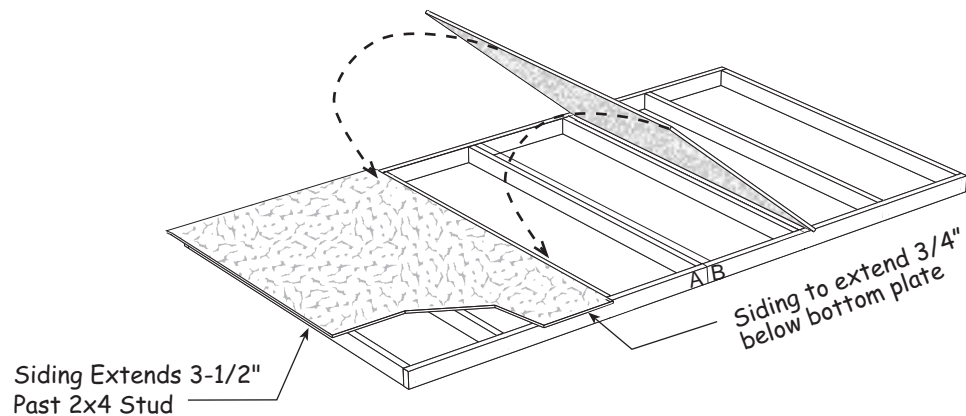

Step 6 Assemble 10' Long Sidewalls

1. Position (2) two 2x4-48" boards and (2) two 2x4-72" boards together and indicate with 'X' marks, where the wall studs will be located.

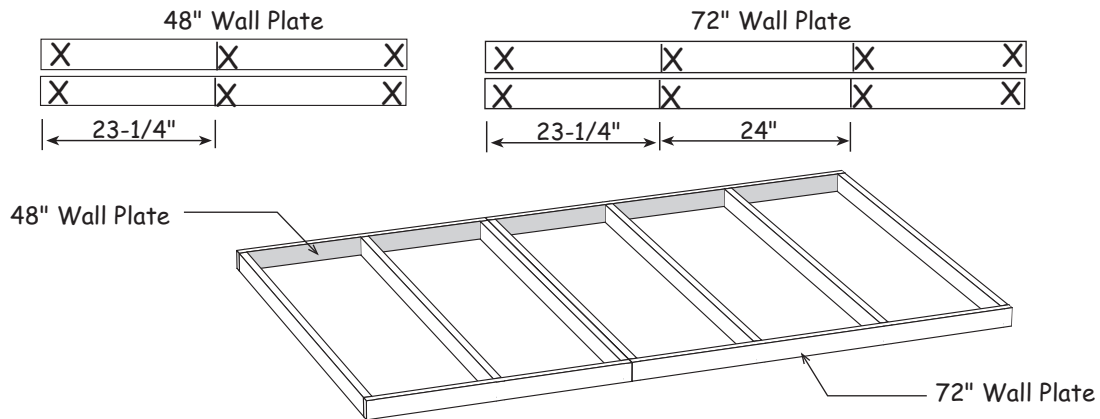

2. Install 2x4-7' wall studs between the top and bottom plates. Nail both wall frames together.
3. Repeat numbers 1 and 2 to assemble (3) three more 10' long sidewall frames.



If you are installing optional windows or walk-in door, see the instructions at the back of the book.

4. Cut (3) three siding panels to a length of 87-1/4". Cut one of the panels in half lengthways.
5. Square wall frame. Select one of the 2' wide panels and install it flush with the end of the wall and extending 3/4" below the bottom plate.
6. Install (2) two more siding panels.

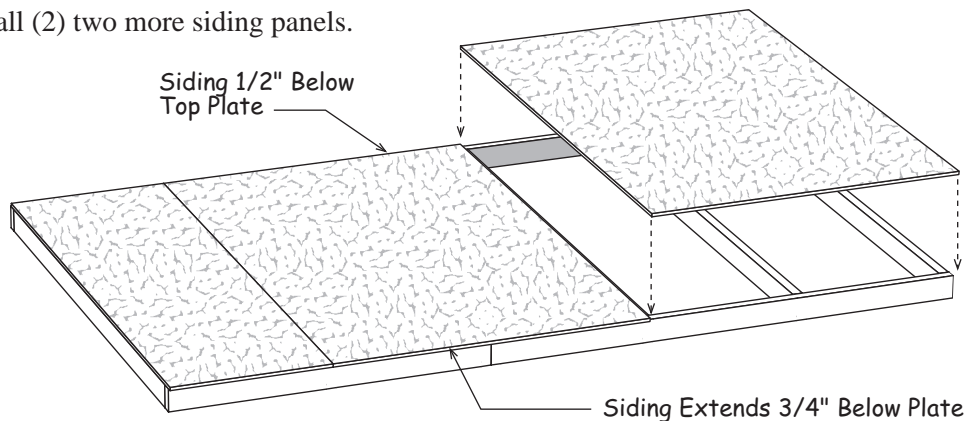

7. Repeat steps 4-6 to install siding on the other 10' wall frames.

Step 7 Assemble Door Header

1. Locate (2) two 2x6 boards and an OSB filler 75" in length.
2. Assemble the door header using 10d sinkers.

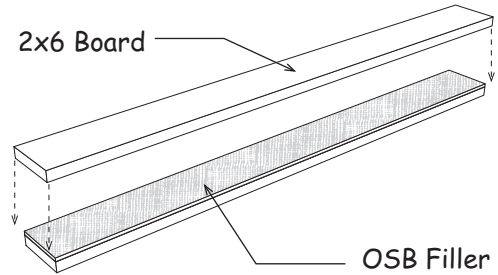

Step 8 Set Walls

1. Set the back wall panel between the sidewalls. Secure wall panels together at the corners. Use (4) four 10d coated nails per corner. Nail wall panels to the floor. Nail through the bottom plate. Space 10d sinkers 24" apart.
2. Install the front wall frames between the sidewalls.
3. Install a 2x4-7' board at the door opening to hold the wall straight.

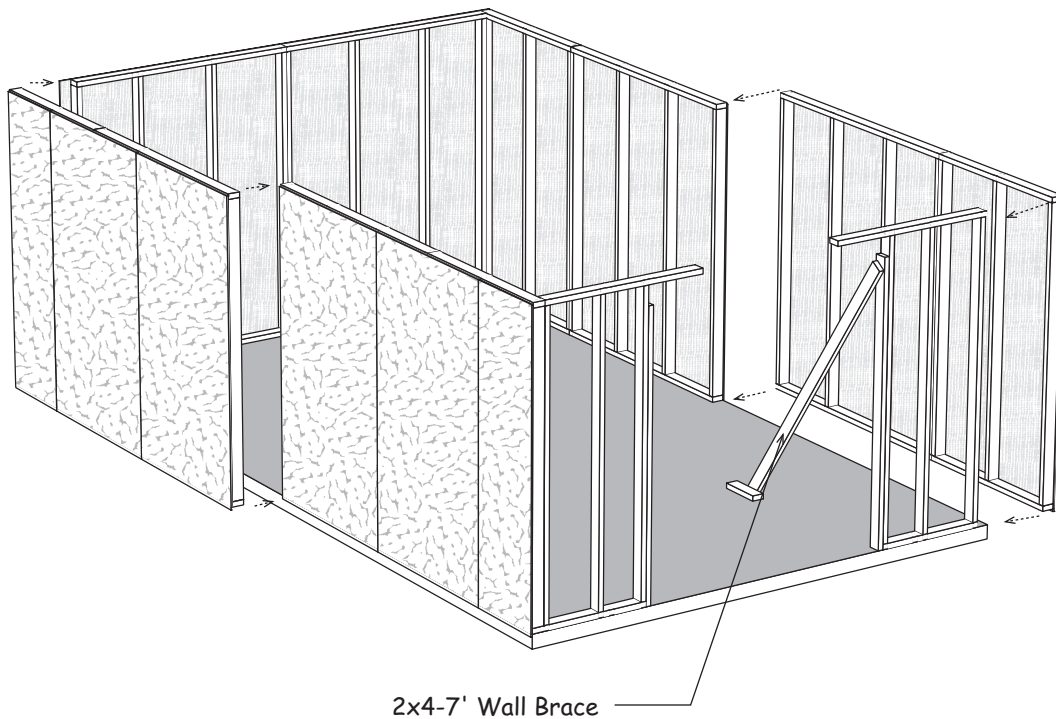

Step 9 Install Siding on Front Wall

1. Install the 2x6 door header between the front wall panels. Nail through the wall stud into the ends of the header. Nail into the header through the top wall plates.
2. Install a 42" long 2x4 over the door header.

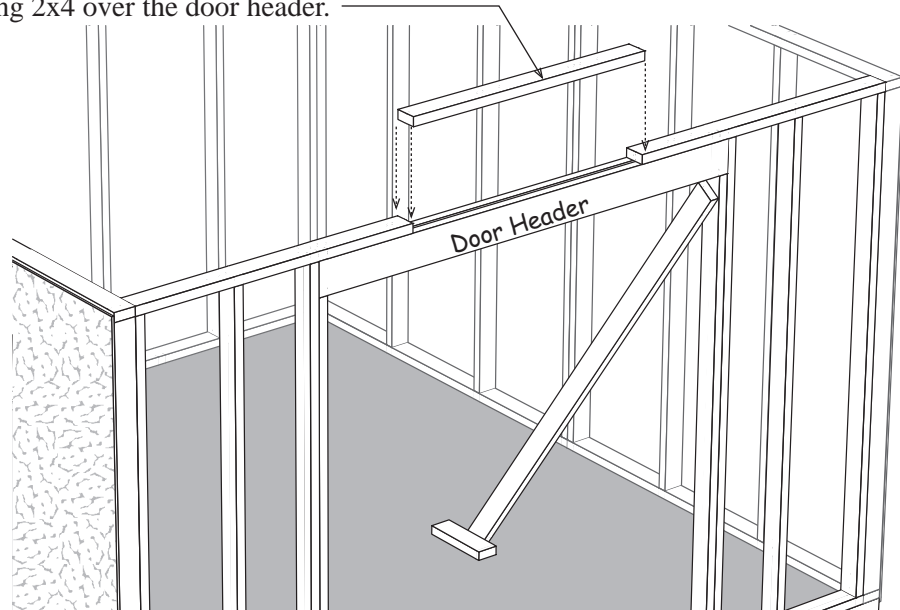

3. Cut (2) two siding panels to a length of 87-3/4". Install the 'left' siding panel flush with the sidewall and extending 3/4" below the bottom plate. Cut siding flush with the door opening.
4. From leftover siding, cut and install a 7" siding panel over the door header.
5. Cut the 'right' siding panel flush with the sidewall siding.

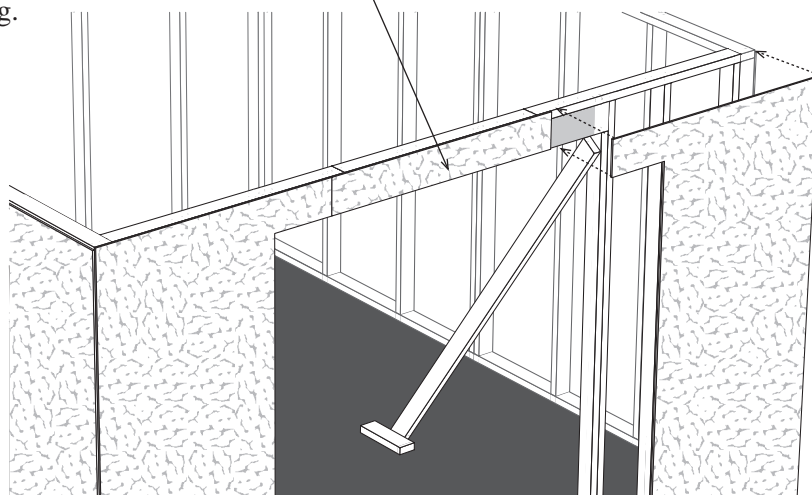

Step 10 Install Roof Gables

1. Install a gable on the rear wall. Secure gable to wall by nailing through the gable plate with 10d sinkers.

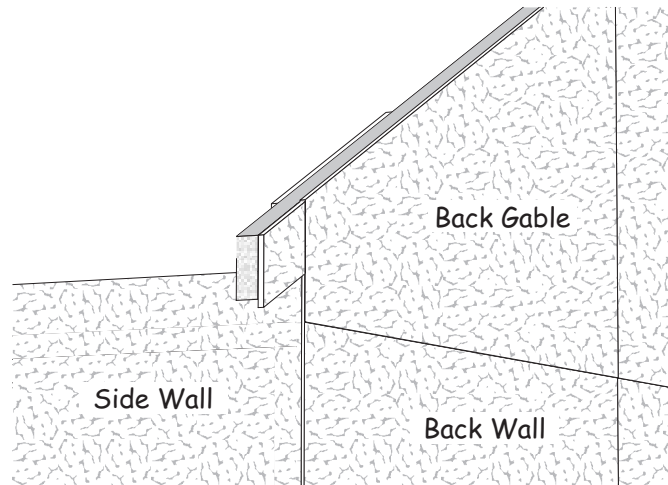

2. Cut 1x4 boards and install as sub-trim on back gable. Install the 1x4 boards flush with the gable frame. This trim will be covered later with 1x6 gable trim and will not be seen. This will create a slot to receive vinyl siding. Refer to Step 17.

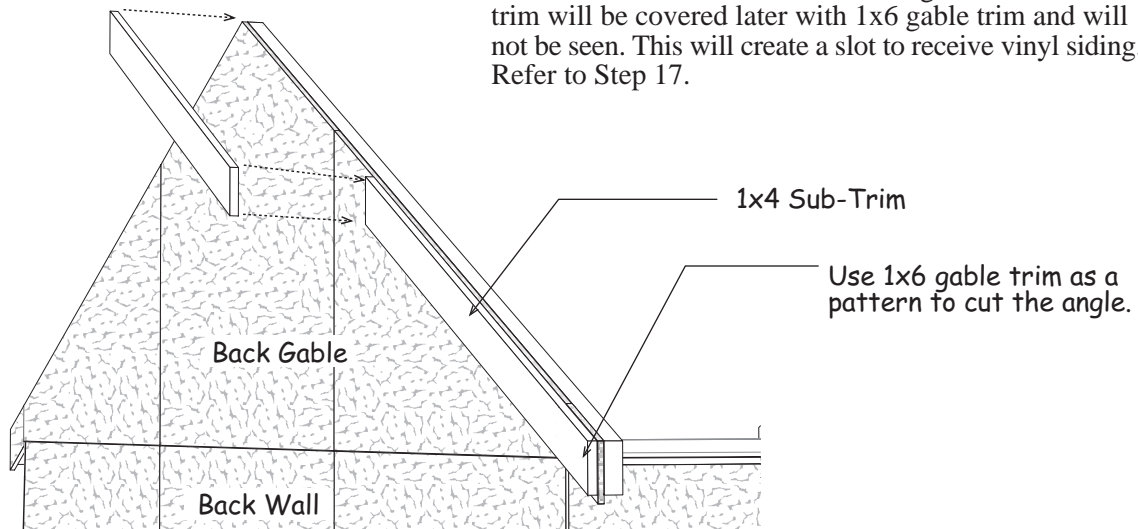

3. Install gable on the front wall. Do not apply 1x4 sub-trim boards.

Step 11 Install 2x4 Tie Plates

1. Install a 2x4-6' board over the sidewall, against the rear gable plate. Use 10d sinkers.

2x4-6' Tie Plates

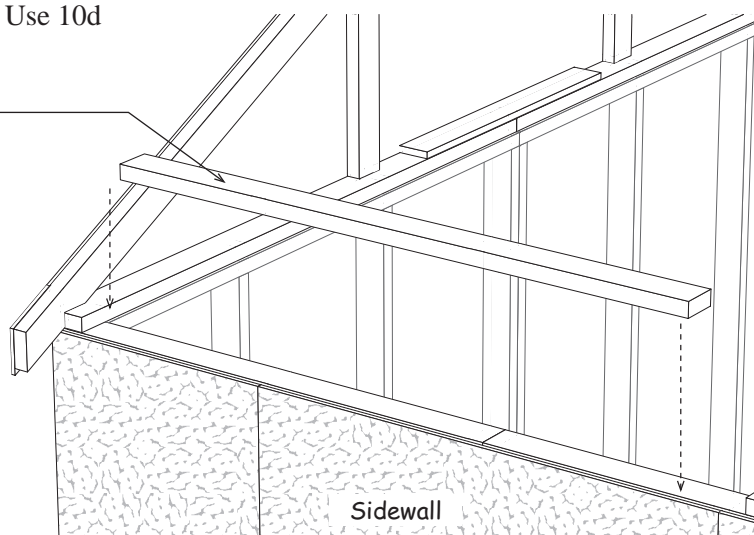

2. Install another 2x4-6' board next to the first one.
3. Install (2) two 48" long 2x4 at the front of the building.
4. Install 2x4 tie plates on the opposite sidewall.

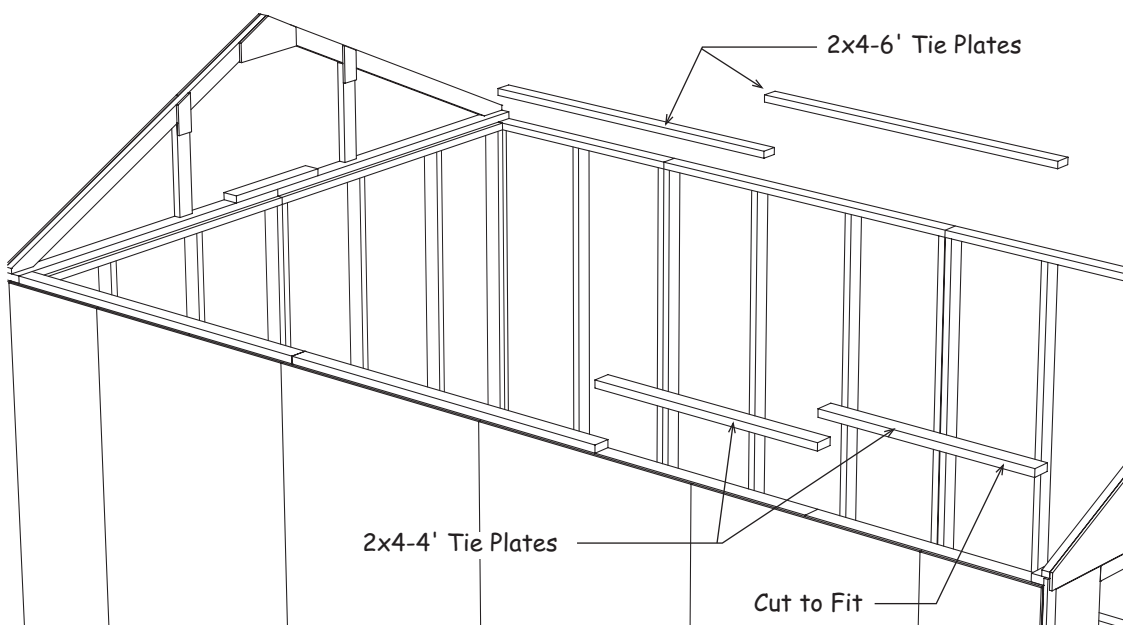

Step 12 Layout Roof Trusses

1. Layout the truss spacing from the rear of the building. Measure from the backside of the 2x4 gable frame when marking the location of the first truss. **Important:** When marking the opposite wall, place the 'X' mark on the same side of the line so your trusses are parallel when they are installed.
2. Install metal hangers to the tie plate with 1-1/2" hanger nails . The opening should line up with the 'X' mark, the bottom of the opening, flush with the 2x4 tie plate. **Detail 'D'**.

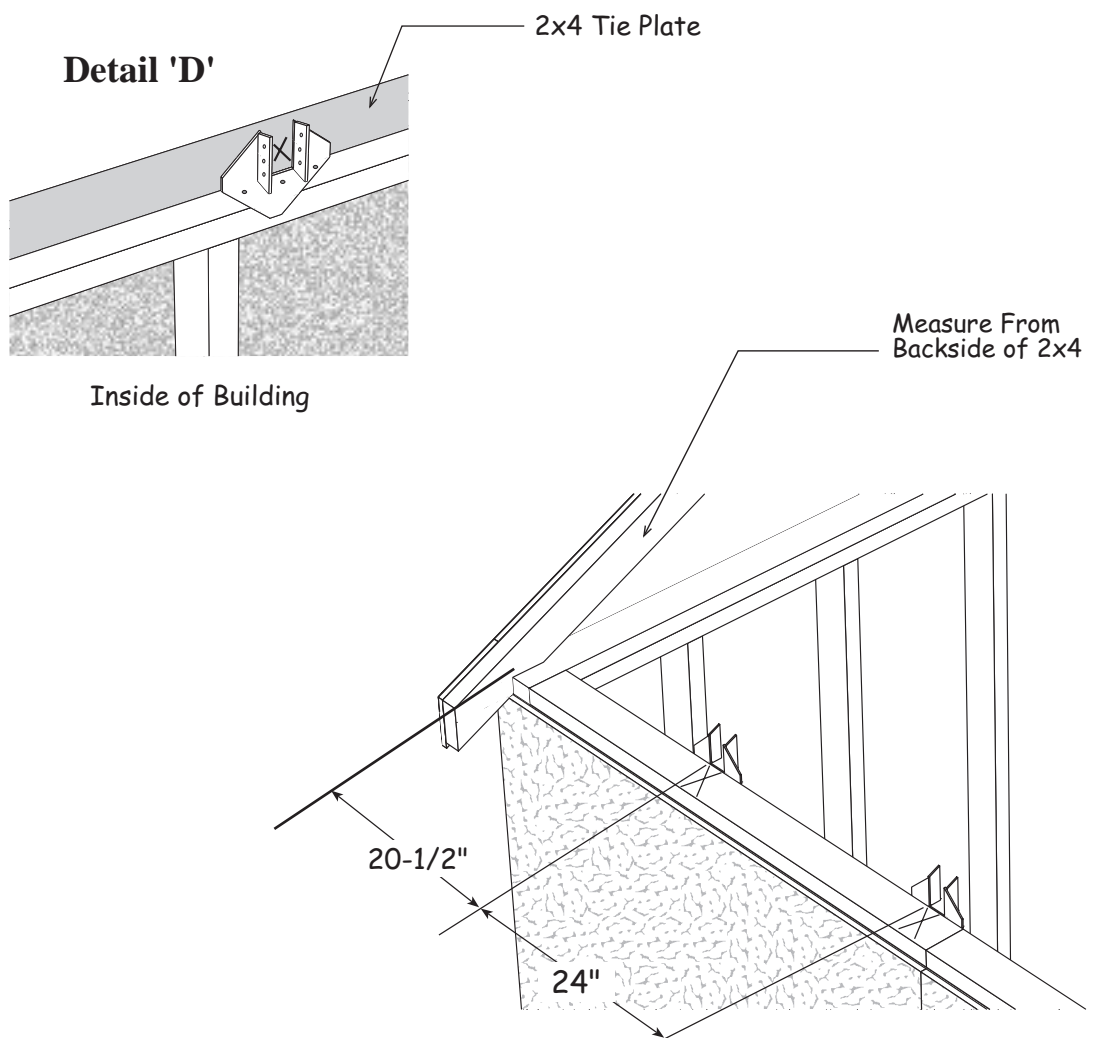

Step 13 Set Roof Trusses

Set roof trusses. Secure trusses to metal hangers with 1-1/2" hanger nails.

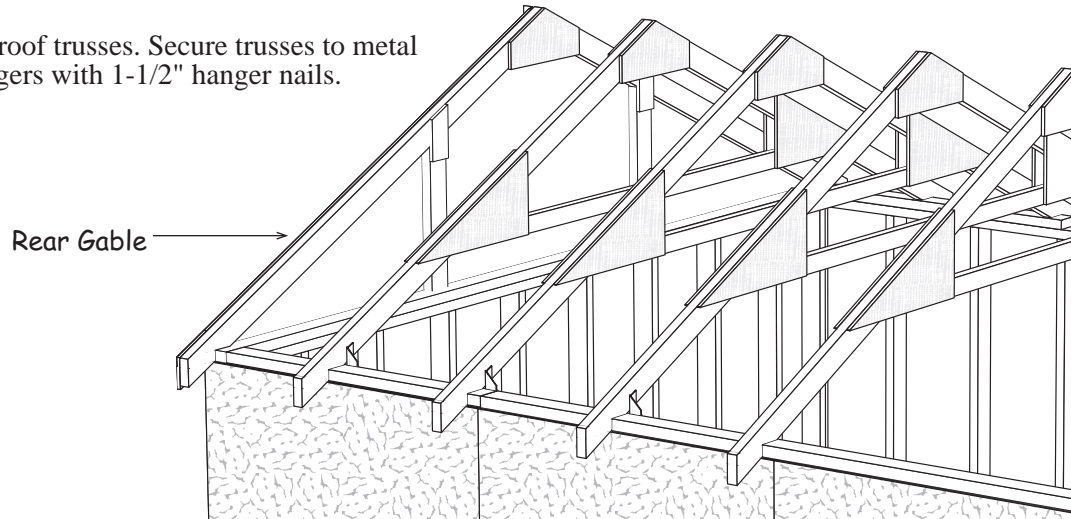

Step 14 Install Eave Soffit

1. Locate a 5" wide x 48" siding panel that has a 'tongue' edge. Install this panel under the truss overhang at the rear of the building. Install the siding/soffit panel with the beveled edge flush with the end of the trusses and the cut edge against the gable siding. Cut the length to meet the center of the truss. Use 6d galv. nails.
2. Install (4) four more full length siding panel under the trusses.
3. Install soffit panels on the opposite side. Start with a 24" long panel that has a 'LAP' edge.

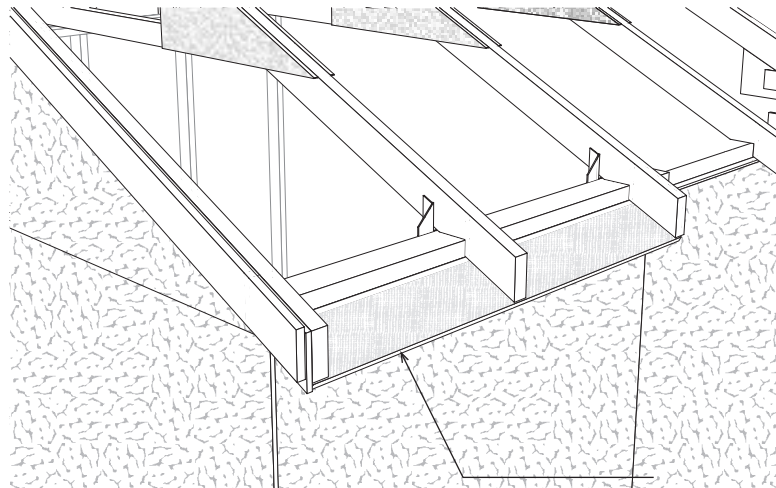

Soffit
Beveled Edge

Step 15 Install Roof Sheathing

1. Starting at the rear of the building, install 4x8 OSB roof panels and 1x6-8' white pine fascia boards on each side. Install the roof sheathing and the 1x6 fascia boards flush with the face of the 1x4 sub-trim on the back gable. Install the fascia so the bottom edge of the roof sheathing will rest on the 1x6. See detail below.

Make sure the trusses are plumb and the roof sheathing meets the center of the truss. Use 7d sinkers spaced 12" apart. Cut a 6' long sheet for the top row. If you are installing ridge vent, cut the roof sheathing about 1" below the ridge to allow for ventilation.

2. Cut and install roof sheathing per layout below.

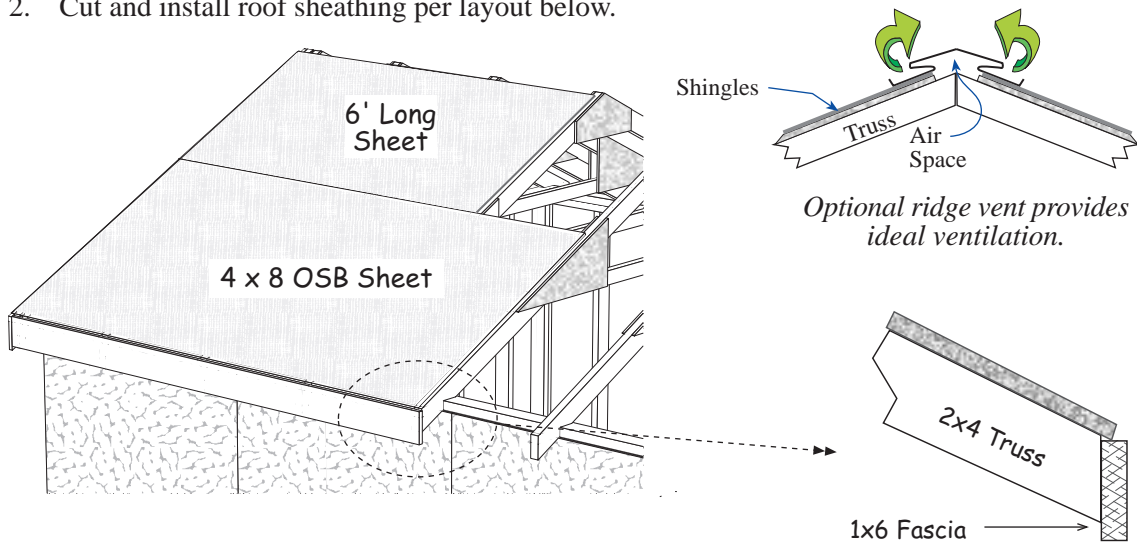

3. Install 1x6-8' fascia in the center of the building. Cut a 1x6-12' trim board in half and install at the front. Use 8d galv. nails.

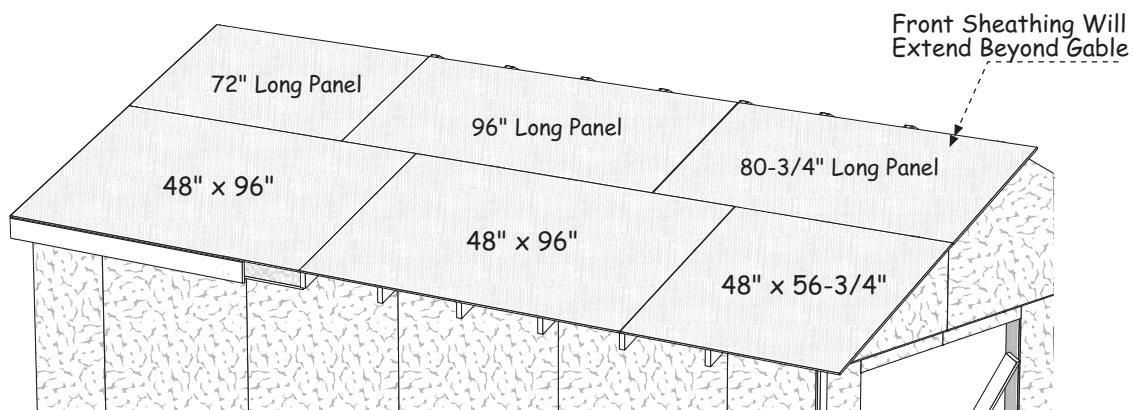

Step 16 Install Front Gable Soffit and Door Trim

1. Install 86-1/4" long 2x4s under the roof sheathing, against the front gable.
2. Install 86-1/4" long 2x4s under the front edge of the roof sheathing. Hold the 2x4s against the roof sheathing and screw through the sheathing into the 2x4 boards using 1-3/4" screws.
3. Install 7" x 48" primed soffit panels under the 2x4s. Use 6d galv. nails.
4. Install (2) two 87" long 1x6 trim boards over the 2x4 boards, flush with the top of the roof sheathing. Use 8d galv. nails.

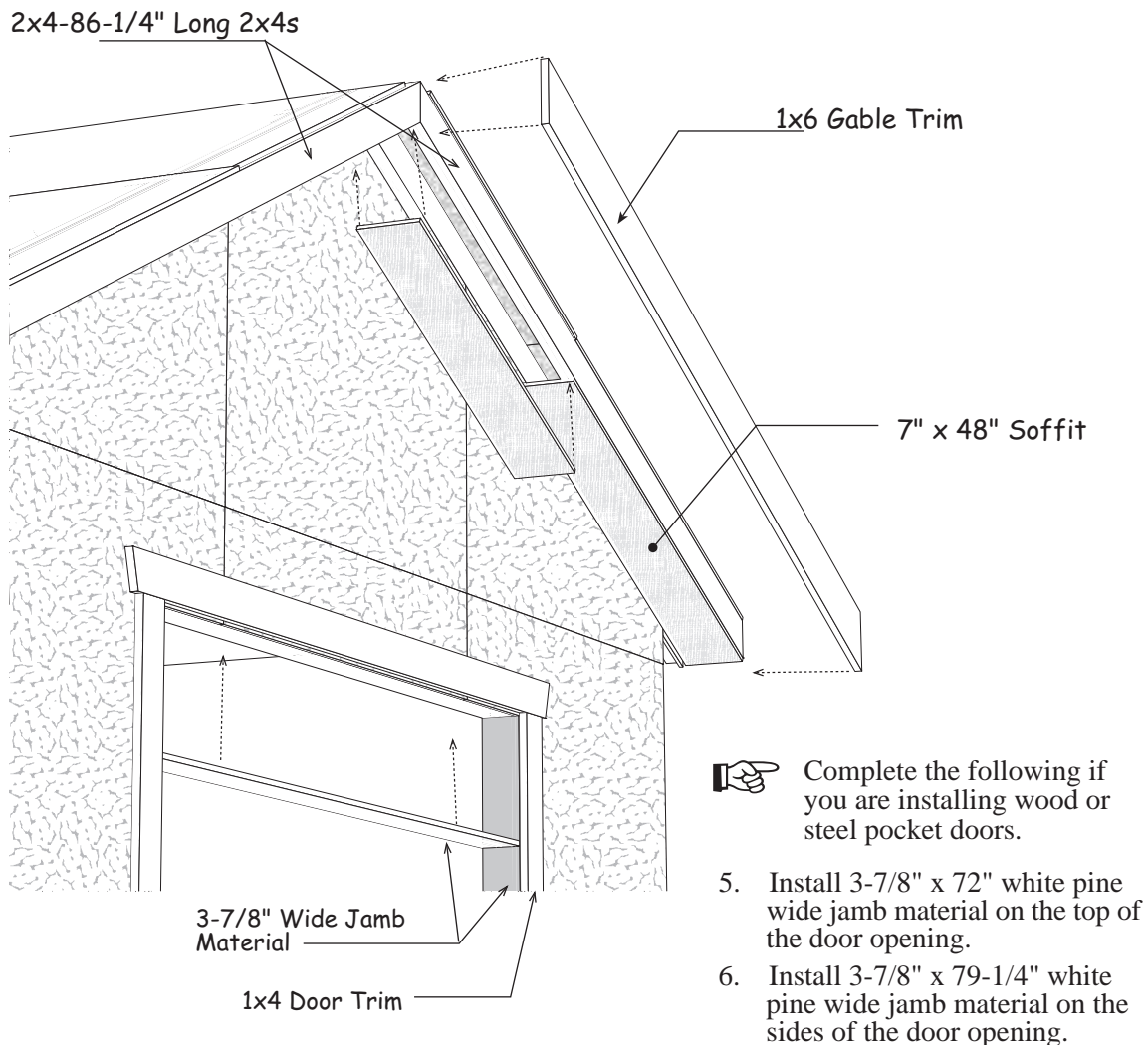

7. Install 80-3/4" long 1x4 trim boards on each side of the door opening. Install an 82" long 1x4 trim board, *this board has angle cuts on both ends*, across the top of the door opening.

Step 17 Install Rear Gable Trim

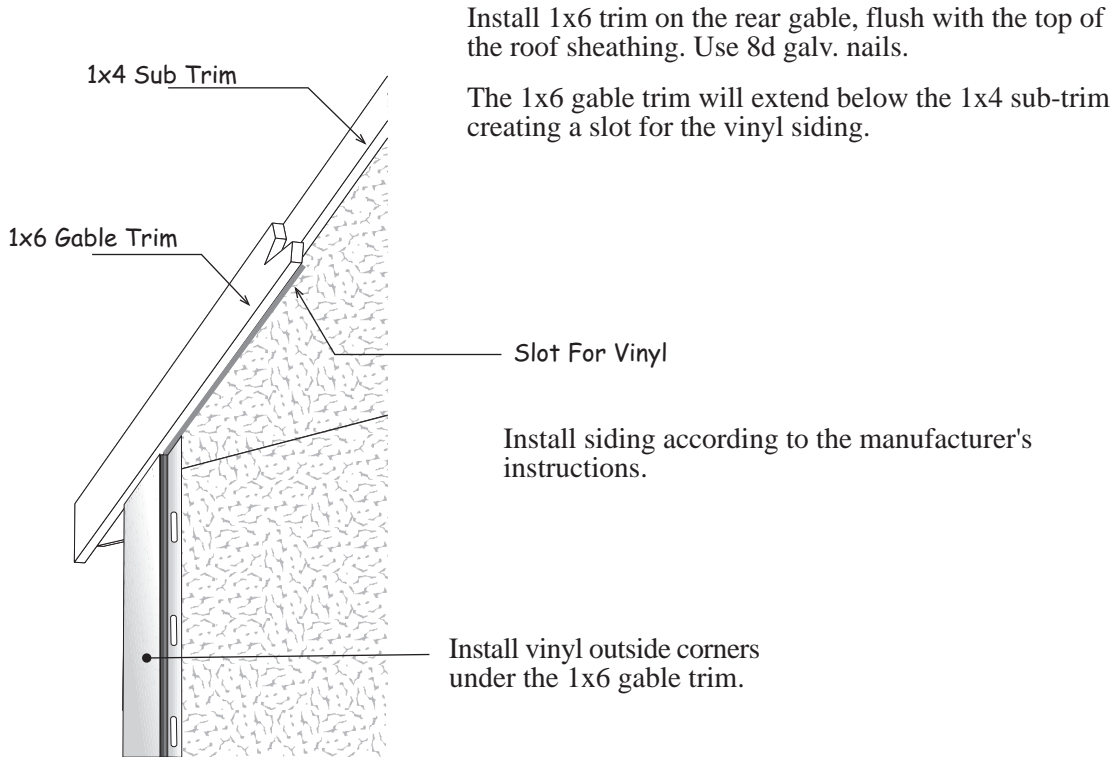

Install Roofing — Not Supplied in Kit

Install metal roof edging perimeter of the roof area. If you are not installing shingles at this time, you can purchase felt paper to protect the roof sheathing. Install the felt paper before you install the metal roof edge.

Install shingles according to the instructions on the wrapper. If you need more detailed instructions on installing shingles, there are good publications at book stores or newsstands.

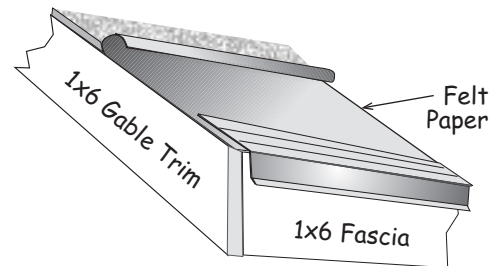

Optional ridge vent provides ideal ventilation.

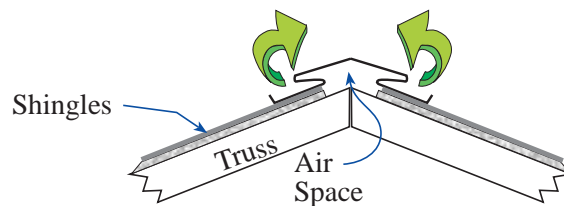

Supplement Details

 This assumes a 92-5/8" long stud length. Adjust accordingly if stud length differs

1. If you purchased a 32"x80" entry door, locate where you want the opening to be and build a 37-1/2" door header. You'll need to cut (4) four 37-1/2" long 2x4s, (3) three 5-5/8" long 2x4s and a 3-1/2"x37-1/2" piece of OSB. If you have a different size door adjust accordingly.
2. Assemble header as shown in Detail 'A'. First assemble (2) two 37-1/2" 2x4s and OSB. Next assemble (1) one 37-1/2" 2x4 and (3) three 5-5/8" 2x4s. Nail this assembly to bottom of previous assembled pieces. Last nail the remaining 2x4 to the 5-5/8" boards. Use 10d sinkers for all.

Detail 'A'

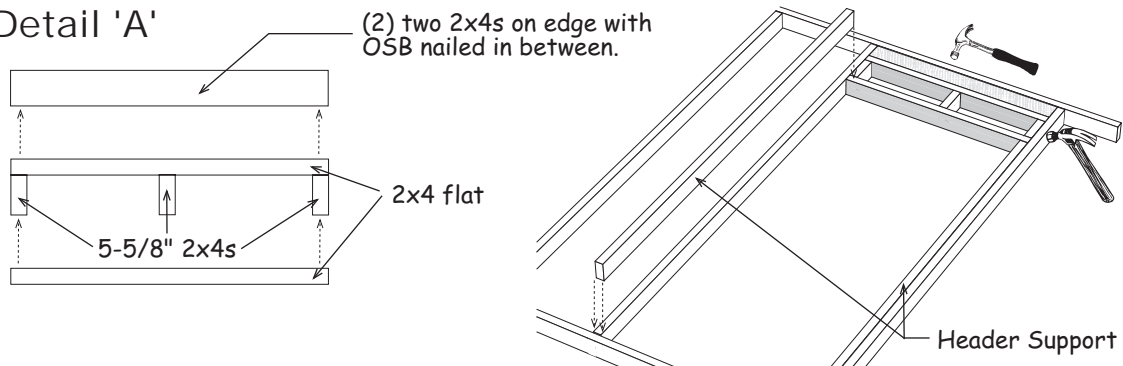

3. Secure the header by nailing through the top plate and wall studs with 10d sinkers.
4. Cut (2) two header supports from pre-cut wall studs and install under the door header.

Material Packaged In Component Kit

9	Collar Ties	2x4	90"	4	1 lb. box	10d	Sinkers
26	Truss Rafters	2x4	86-1/4"	4	1 lb. box	8d	Galv.
46	Wall Studs	2x4	84"	3	1 lb. box	7d	Sinkers
16	Wall Plates	2x4	72"	1	1 lb. box	6d	Galv.
4	Wall Plates	2x4	68-1/2"	4	1 lb. box	6d	Common
12	Wall Plates	2x4	48"	2	1 lb. box	1-1/2"	Hanger Nails
2	Wall Plates	2x4	47-1/2"	24	ea.	2-1/2"	Wood Screws
1	Tie Plate	2x4	42"	36	ea.	1-3/4"	Wood Screws
2	Wall Plates	2x4	31"	6	ea.	1x4	Metal Plates
4	Gable Studs	2x4	23-1/2"	2	ea.		Bottle Glue
8	Truss Jig Blocks	2x4	10"	4	ea.	1x6 Gable Trim	87"
2	Door Header	2x6	75"	8	ea.	1x4 Corner Trim	87-3/4"
18	Truss Gussets	7/16"	8" x 20"	4	ea.	1x4 Wall Trim	72"
36	Truss Gussets	7/16"	12" x 24"	4	ea.	3/8" Soffit Panels	7" x 48"
10	Soffit Boards	3/8"	5" x 48"	2	ea.	3/4" Plywood Gusset	3-1/2" x 32"
18	2x4 Metal Truss Hangers			1	ea.	7/16" OSB Filler	5-1/4" x 75"

Material Supplied by Local Supplier

17 pcs.	Exterior Siding	4x8	7/16"
12 pcs.	OSB Sheathing	4x8	7/16"
4 pcs.	1x6 - 8'	White Pine Fascia	
1 pc.	1x6- 12'	White Pine Fascia	

Shingles Purchased Separately

12 bdl.	Roof Shingles		
9 pcs.	Roof 'drip' Edge	10'	